

 **AIPHONE**[®]

Color
Video Brochure

The **Power** to *Identify*...

with **Video Entry Security**



■ COMMERCIAL ■ CORRECTIONAL ■ EDUCATIONAL ■ HEALTHCARE ■ GOVERNMENT



The MAJORITY of employees victimized by workplace violence **DID NOT KNOW** their assailant!*

The SOLUTION?



Add "eyes & ears" with Aiphone's Color Video Entry Security Intercoms to complete **Access Control Systems**

*U.S. Dept. of Justice

Ideal for most industry markets - See page 15 to help determine where Color Video Entry Security is critical!



TABLE OF CONTENTS

Systems		Feature Icons	Page Number	Video Identification	Picture Memory	Video Signal Output (NTSC)	Vandal Resistant Door Stations	Card Access / Keyless Entry	Door Release	Public Address / Overhead Paging	Internal / Point-to-Point Communication	CCTV Input
DOOR/SUB 120	INSIDE 8	AX Series INTEGRATABLE AUDIO & VIDEO SECURITY	4 & 5									
DOOR 3	INSIDE 5	KB Series VIDEO SENTRY COLOR TILT	6 & 7									
DOOR 2	CCTV 2	INSIDE 3	JA Series HANDS-FREE COLOR VIDEO WITH PAN/TILT	8 & 9								
DOOR 2	INSIDE 3	JF Series HANDS-FREE COLOR VIDEO (JF-2MED)	10 & 11									
DOOR 1	INSIDE 2	JF Series HANDS-FREE COLOR VIDEO (JF-1MD)	12 & 13									
DOOR 1	INSIDE 3	KC Series VIDEO SENTRY COLOR TILT	14									

Video Identification
Confirm a visitor's identity before granting access into a building.

Aiphone's video systems allow users to clearly see and hear callers from the door to the master station with crisp audio and up-close video images.

Picture Memory
Record for security purposes or reference later for missed visitors.

If a call is received from the door station the master/memory unit records the picture frame sequence automatically. Manual recording is also an option!

Video Signal Output (NTSC)
Integrate with existing DVR's or various display and monitoring devices.

Standard composite video output utilizes the video being seen on a master station to be viewed and/or recorded on a much larger display or monitor.

Vandal Resistant
Enhance overall building security with vandal resistant door stations.

Many of Aiphone's exterior video door stations are constructed to resist not only vandalism and damage, but harsh weather conditions as well!

Card Access / Keyless Entry
HID® embedded door stations are ideal where keyless entry is wanted or required.

Card readers allow for individuals with appropriate credentials to conveniently gain access into a secured building, while keeping the doors locked for safety.

Door Release
Once a visitor is approved for entry, they can be let it by the touch of a button!

Door release provides users the ability to remotely unlock entrances at the master station. The door where communication is establish is the only one unlocked!

Public Address /Ovrhd. Paging
Broadcast important or basic routine messages by integrating with a PA system.

Users can make general announcements or emergency notifications, which then can be heard in a specific room/area or throughout an entire building.

Internal /Point-to-Point Comm.
Interior stations provide the convenient feature of instant communication.

With point-to-point communication individuals can relay simple messages to one another or alert each other of any urgent situation.

CCTV Input
Complement up-close images on a master station with the broad view of CCTV.

By integrating with CCTV cameras, users can see an expansive view of an entry way. This eliminates the fear of individuals "lurking" behind corners.

DOOR/SUB
120

INSIDE
8

AX Series

Integratable Audio/Video Security



Door Stations - Max. 120 doors

MIX & MATCH - Up to 120 TOTAL AX Door/Sub Stations



AX-DV
Fixed Video Door Station, aluminum die cast, surface mount



AX-DVF
Fixed Video Door Station, stainless steel, flush mount



AX-DV-P
Fixed Video Door Station with embedded HID® ProxPoint® Plus Proximity Card Reader, aluminum die cast, surface mount



AX-DV-XP
Fixed Video Door Station with embedded Stand-Alone Card Reader and host controller, aluminum die cast, surface mount



AX-DVF-P
Fixed Video Door Station with embedded HID® ProxPoint® Plus Proximity Card Reader, stainless steel, flush mount



AX-DVF-P
Fixed Video Door Station with embedded Stand-Alone Card Reader and host controller, stainless steel, flush mount

Audio Only



AX-DM
Door Station, plastic cover, mullion surface mount



IF-DA
Door Station, plastic cover, surface mount



IE-DC
Door Station, plastic and aluminum cover, surface mount



IE-JA
Door Station, stainless steel faceplate, flush mount



IE-SS
Door Station, stainless steel, flush mount



IE-SSR
Door Station, stainless steel, red mushroom call button, flush mount



IE-SSV
Door Station with a built-in CCTV camera, stainless steel, flush mount (Requires AXW-AZ)

Central Exchange Unit



AX-084C
Central Exchange Unit for 8 doors and 4 masters



AX-248C
Central Exchange Unit for 24 doors and 8 masters

Add-on Unit



AX-320C
Add-on Exchange Unit for 32 doors

CAT-5e wire
N/A from Aiphone (Max. 980')

CAT-5e wire
N/A from Aiphone (Max. 980')

2x2 wires
Aiphone #822202 (Max. 33')

PS-2420UL
Power Supply
24V DC, 2A

Features

- CAT-5e wiring homerun from each station
- Up to 8 masters and 120 door stations
- Two talk channels
- PTT or VOX operation
- Selective calling between masters, and from masters to door/sub stations
- Masters available with 3.5" color TFT LCD
- Composite video output from CEU and video masters
- Normal or priority call levels
- Data output on CEU provides custom integration capability with CCTV and access control systems*
- PC programmable with a large variety of settings
- All Call or Group Call to master stations
- Compatible with IE and IF Series door stations
- Transfer calls to an outside phone line (requires Viking Model K-1900-5 programmable dialer)
- Scan monitoring
- Optional Features: Headset, footswitch, call transfer to telephone, and PC remote control*

*Interface requires custom program (not supplied by Aiphone)

Unit Dimensions

NOTE: For unit dimensions of the IE Series door stations see pg. 7

AX-084C, AX-248C, AX-320C

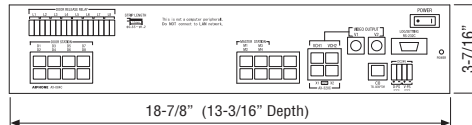

AX-8M, AX-8MV

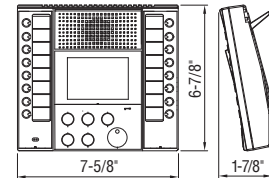

AX-16SW

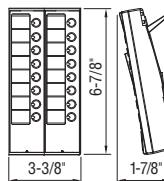

AX-DM

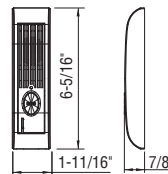

AX-DV

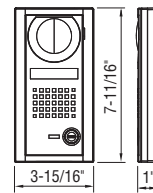

AX-DVF

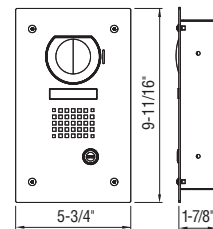

AX-DV-P

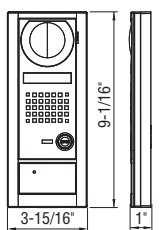

AX-DVF-P

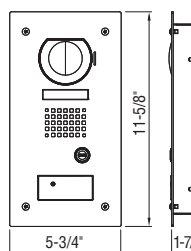

AX-A, AX-AN

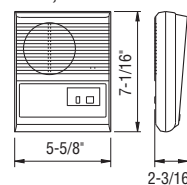

AX-B, AX-BN

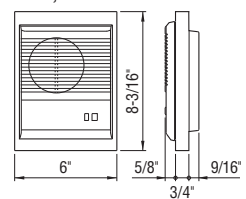

Inside Stations - Max. 8 rooms



AX-8MV
Color Video Master Station, wall or desk mount



AX-8M
Audio Only Master Station, wall or desk mount

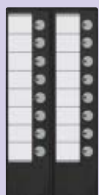

AX-16SW
16-Call Add-on Selector



AX-8MV-W
WHITE Color Video Master Station, wall or desk mount (Up to max. of 8 door stations and 8 master stations)

Sub Stations

MIX & MATCH - Up to 120 TOTAL AX Door/Sub Stations



AX-A
Sub Station, surface mount



AX-AN
Privacy Sub Station, surface mount



AX-B
Sub Station, semi-flush mount



AX-BN
Privacy Sub Station, semi-flush mount

Options & Accessories



XP Kit
Includes keypad (XRP3), programming cards, and 10 blank entry cards (XC5T9)



HID-SS
Accessory Station with an embedded HID® Proximity Card Reader



ICP-BR & ICP-AB
Brass Faceplate for IE-JA and LE-DA and IE-JA and LE-DA



SBX-2G
Surface Mount Box for IE-JA, IE-SS, IE-SSR, and IE-SSV

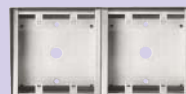

SBX-2BH
Horizontal Mount Box for HID-SS and IE-SS, IE-SSR, IE-SSV, LE-SS, LE-SSR, or LE-SSV (Vertical mount also available - **SBX-2BV**)



SBX-DVF-P
Surface Mount Box for AX-DVF-P



SBX-AXDV30
30" Surface Mount Box for AX-DV



AXW-PA1
Paging Adaptor



AXW-AZ
CCTV Camera Input Module



AXW-AVT
Door Station IP or Fiber Optic Transmission Interface Unit



AXW-AVR
Door Station IP or Fiber Optic Reception Interface Unit



EL-10S
Electric Door Strike, 12V AC, 180mA (Requires PT-1210N)



IER-2
Call Extension Speaker



TAR-3
External Signaling Relay (Requires SKK-620B)



RY-24L
Form C High Current Door Release Relay (1 door)

Wiring

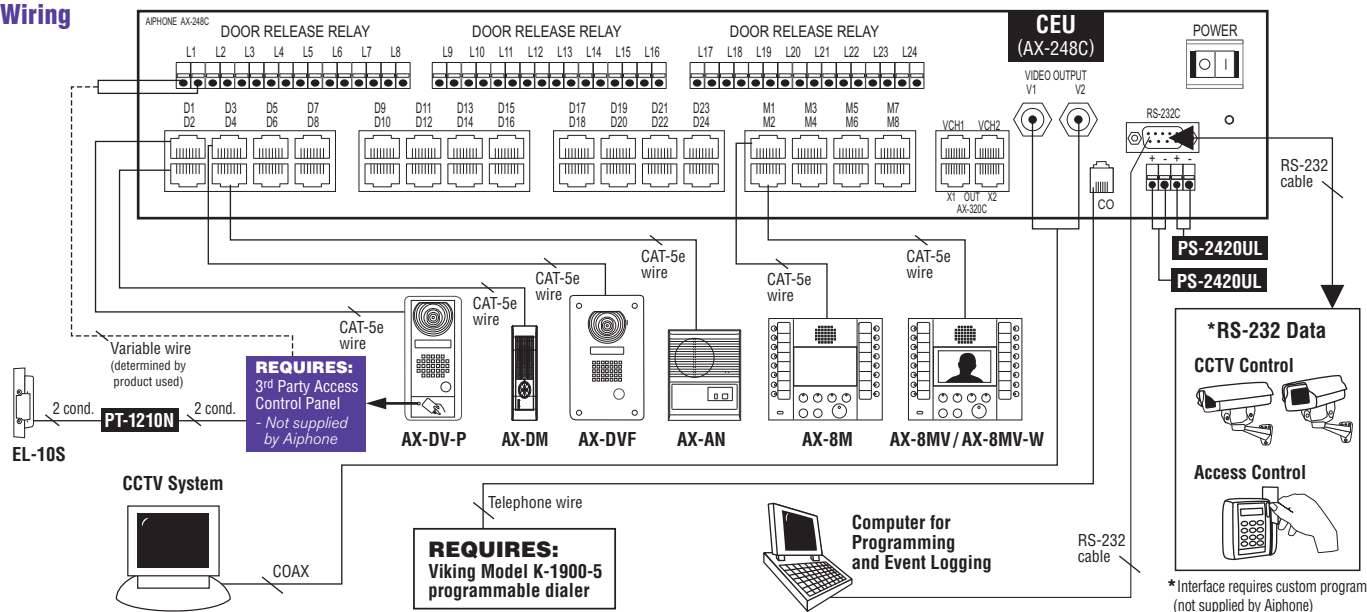

Specifications

- Power source** 24V DC - Use two PS-2420UL
- Calling** Chime and image 10-600 secs. (programmable) or infinite
- Communication** Press TALK button to reply, communication times out in 30-600 secs. (programmable)
- Video Monitor** 3-1/2" direct view TFT color LCD

- Camera** 250,000 pixels
- Scanning Line** 525 lines
- Door Release** Programmable N/O or N/C dry contact, 24V AC/DC, 500mA max.
- Wiring** Homerun CAT-5e wire to CEU
- Distance** Door stations to CEU: 980' CEU to master stations: 980'
- Wire type** CEU to master stations: CAT-5e Video Door stations to CEU: CAT-5e IE door stations to CEU: CAT-5e



Door Stations - Max. 3 doors

DOOR 1 OPTIONS
 Choose ONE of the following

KB-DAR
 Color Tilt Video Door Station, plastic cover, surface mount

KB-DAR-M
 Color Tilt Video Door Station, motion detector interface, plastic cover, surface mount

DOOR 2 OPTIONS
 Choose ONE of the following

KB-DAR

KB-DAR-M

KBW-M
 CCTV Input Module

DOOR 3 OPTIONS
 Choose ONE of the following

KB-DAR

KB-DAR-M
 Color Tilt Video Door Station, motion detector interface, plastic cover, surface mount

IF-DA
 Door Station, plastic cover, surface mount

IE-DC
 Door Station, plastic and aluminum cover, surface mount

IE-JA
 Door Station, stainless steel faceplate, flush mount

IE-SS
 Door Station, stainless steel, flush mount

IE-SSR
 Door Station, stainless steel, red mushroom call button, flush mount

KBW-M
 CCTV Input Module

Inside Stations - Max. 5 rooms

INSIDE 1 OPTION
 Choose ONE of the following

KB-3MRD
 Master Station with color monitor

KB-3HRD x 2
 (Max. 330' between masters and farthest sub)

PS-2420UL
 Power Supply, 24V DC, 2A
 (One PS-2420UL per two video monitors)

RY-3DL
 Selective Door Release Adaptor

EL-10S
 Door Strike

Aiphone #871802
 (Max. 650')

Aiphone #871802 x 2
 (Max. 330' between masters and farthest sub)

Aiphone #871802
 (Max. 33')

Features

- Clear and bright image with color TFT LCD monitor and color video door station
- Three color video door stations, five inside monitor stations
- Instant voice call-in with image
- PTT or VOX operation
- Selective Call or All Call
- Chime or receiver volume control
- Optional selective door release with RY-3DL
- 330' total distance looped between monitors
- TILT camera control

Camera View Area

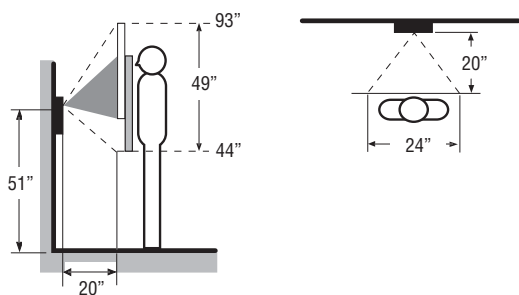

Wiring

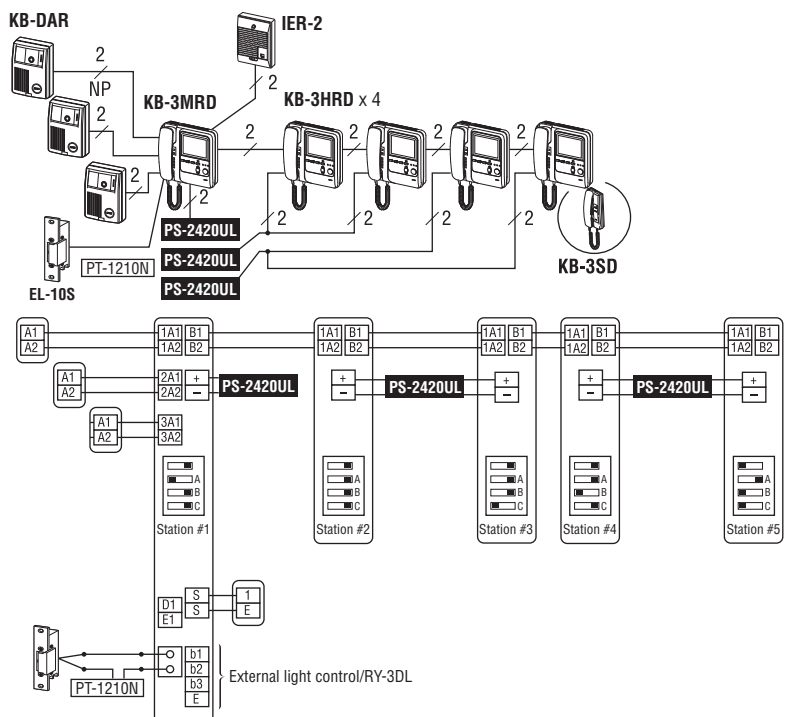

NOTES: 1. D1 and E1 for IE Series door stations (audio only) instead of third KB-DAR
 2. Run audio/video wires in a separate jacketed cable from door release wires

INSIDE
2-3
OPTIONS

Choose from the following



KB-3HRD
Sub Master Station with color monitor



KB-3SD
Audio only Sub Master Station
(Only 2 KB-3SD's per system)

4 wires
Aiphone
#871802 x 2
(Max. 330'
between master
and farthest sub)

PS-2420UL
Power Supply,
24V DC, 2A
(One PS-2420UL per
two video monitors)

2 wires
Aiphone
#871802
(Max. 33')

INSIDE
4-5
OPTIONS

Choose from the following



KB-3HRD
Sub Master Station with color monitor



KB-3SD
Audio only Sub Master Station
(Only 2 KB-3SD's per system)

PS-2420UL
Power Supply,
24V DC, 2A
(One PS-2420UL per
two video monitors)

2 wires
Aiphone
#871802
(Max. 33')

Options & Accessories



HID-SS
Accessory Station with Embedded HID® Proximity Card Reader



ICP-BR & ICP-AB
Brass Faceplate for IE-JA
Antique Brass Faceplate for IE-JA



SBX-2G
Surface Mount Box for IE-JA, IE-SS, and IE-SSR

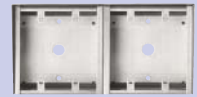

SBX-2BH
Horizontal Mount Box for HID-SS and IE-SS or IE-SSR (Vertical mount also available - **SBX-2BV**)



SBX-ACE
Surface Mount Box for intercom and access control device



KAW-D
30° Angle Box for KB-DAR and KB-DAR-M



KMB-45
Mullion Mounting Bracket for KB-DAR, KB-DAR-M, IF-DA and IE-DC



KA-DGR Panel
Housing Panel for KB-DAR and KB-DAR-M, stainless steel, surface mount



KA-FSH
Housing Panel, stainless steel, flush mount



KC-32EU
Picture Memory Unit



EL-10S
Electric Door Strike, 12V AC, 180mA
(Requires PT-1210N)



RY-3DL
Selective Door Release Adaptor



RY-24L
Form C High Current Door Release Relay
(1 door)



IER-2
Call Extension Speaker



TAR-3
External Signaling Relay
(Requires SKK-620B)



MCW-S/A
Monitor Desk Stand

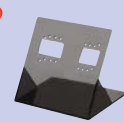

MCW-2S
Monitor/Picture Memory Unit Desk Stand

Unit Dimensions

KB-3MRD, KB-3HRD

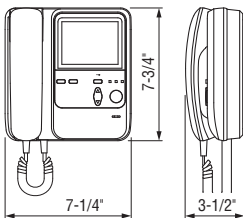

KB-3SD

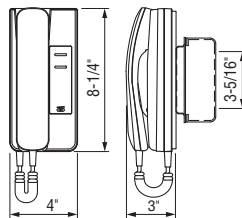

KB-DAR

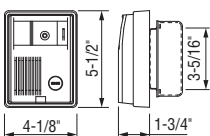

IF-DA

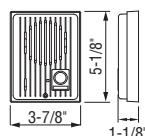

IE-DC

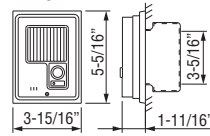

IE-JA

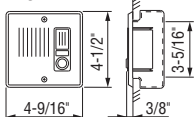

IE-SS, IE-SSR, IE-SSV

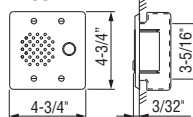

Specifications

Power Source 24V DC - Use PS-2420UL

Calling Chime, image and audio approx. 30 sec., hear and see door instantly

Communication Pick up at any station to reply, 2-1/2 min. timed, recycle with MONITOR, monitor audio and image of door, hands-free with MONITOR, press a station selector and call by voice, the called station replies hands-free, lift handset, press All Call button to call the other stations with pre-tone and voice

Video Monitor 4" direct-view TFT color LCD

Scanning Line 525 lines

Image View Area Approx. 2' horizontal, 3'8"~7'9" vertical at 4'3" high and at 20" in front of camera

Night Viewing Up to 1' from camera, with white LED projected, background beyond 1' cannot be seen

Door Release Contact rating: 12V AC, 400mA
Use RY-24L for larger contact rating

Wiring Door to master: 2-cond., mid cap, solid, non-shielded
Master to subs: 2x2-cond., mid cap, solid, non-shielded

Distance Master to door: 330'(22AWG) 650'(18AWG)
Master to farthest sub: 165'(22AWG) 330'(18AWG)
Master to IER-2: 165'(22AWG) 330'(18AWG)

Wire Type Aiphone #871802

DOOR 2 → CCTV 2 → INSIDE 3

JA Series

Hands-free Color Video with PanTilt



Door Stations - Max. 2 doors

DOOR 1
OPTIONS

Choose **ONE** of the following

JA-DAC
PanTilt Video Door Station, plastic cover, surface mount

JA-DGC
PanTilt Video Door Station, aluminum panel, semi-flush mount

JA-DGV
PanTilt Video Door Station, stainless steel, flush mount

DOOR 2
OPTIONS

Choose **ONE** of the following

JA-DAC

JA-DGC

JA-DGV

JA-D
Audio Only Door Station, plastic cover, surface mount

JAW-AZ
CCTV Input Module

CCTV - Max. 2 cameras

CAMERA 1~2
OPTIONS

JAW-AZ
CCTV Input Module

Inside Stations - Max. 3 rooms

INSIDE 1
OPTIONS

Choose **ONE** of the following

JA-2MCD
Master Station with PanTilt color monitor

JA-2MECD
Master Station with PanTilt color monitor and Picture Memory

2 wires
Aiphone #871802 (Max. 330')

2 wires
EL-10S Door Strike

2 wires
Aiphone #871802 (Max. 330')

2 wires
EL-10S Door Strike

4 wires
Aiphone #871804 (Max. 330' between master and farthest sub)

2 wires
Aiphone #871802 (Max. 33')

PS-2420UL
Power Supply, 24V DC, 2A

2 wires
Aiphone #871802 (Max. 330')

Features

- Two color PanTilt camera door stations, three inside monitor stations
- Motion-sensor camera for monitoring with JDW-C
- Hands-free communication, voice operated exchange (VOX)
- Instant voice call-in with image
- Press-to-talk (PTT) operation can override VOX if necessary
- Built-in video output
- All Call to all inside stations
- Visual monitoring with audio
- Two door release contacts for selective control
- Built-in picture memory (JA-2MECD only)
- Transfer of door station call to other inside stations
- White LED illuminator turns on in low-light conditions

Camera View Area

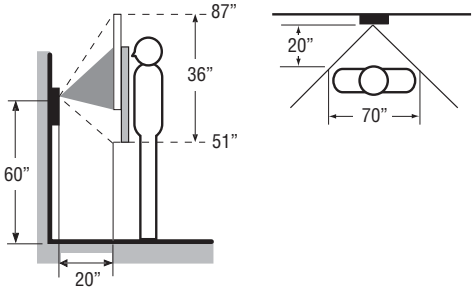

Wiring

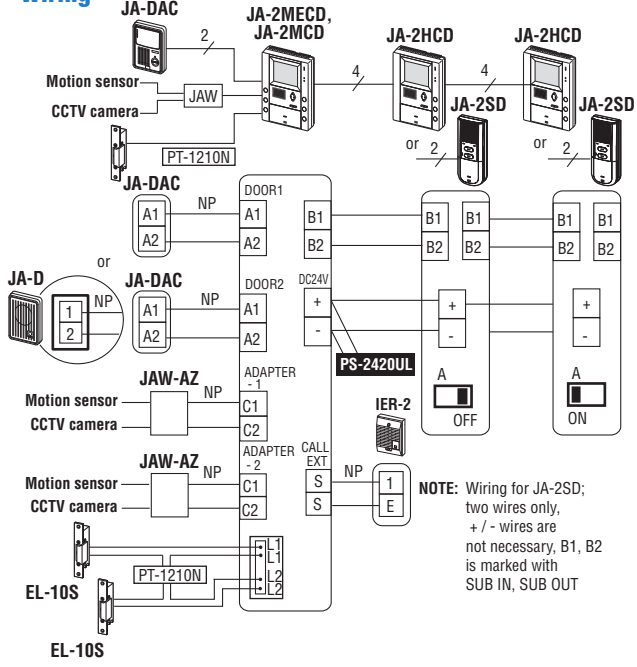

INSIDE
2
OPTIONS

Choose ONE of the following



JA-2HCD
Sub Master Station
with PanTilt
color monitor



JA-2SD
Audio Only
Sub Master Station

INSIDE
3
OPTIONS

Choose ONE of the following



JA-2HCD
Sub Master Station
with PanTilt
color monitor



JA-2SD
Audio Only
Sub Master Station

4 wires
Aiphone
#871804
(Max. 330'
between
master and
farthest sub)

Options & Accessories



KAW-D
30° Angle Box
for JA-DAC



KMB-45
Mullion Mounting
Bracket for JA-DAC
and JA-D



SBX-ACE
Surface Mount
Box for intercom
and access
control device



SBX-DGV
Surface Mount
Box for JA-DGV



MKW-DK/A
Motion Detector
Adaptor for video
door station



JBW-BA
Long Distance
Door Station
Adaptor



EL-10S
Electric Door Strike,
12V AC, 180mA
(Requires PT-1210N)



RY-24L
Form C High
Current Door
Release Relay
(1 door)



TAR-3
External
Signaling Relay
(Requires SKK-620B)



IER-2
Call Extension
Speaker

Boxed Sets

JA Series Box Set

JAS-2MCD: JA-2MCD, JA-DAC & power supply
JAS-2MECD: JA-2MECD, JA-DAC & power supply

Unit Dimensions

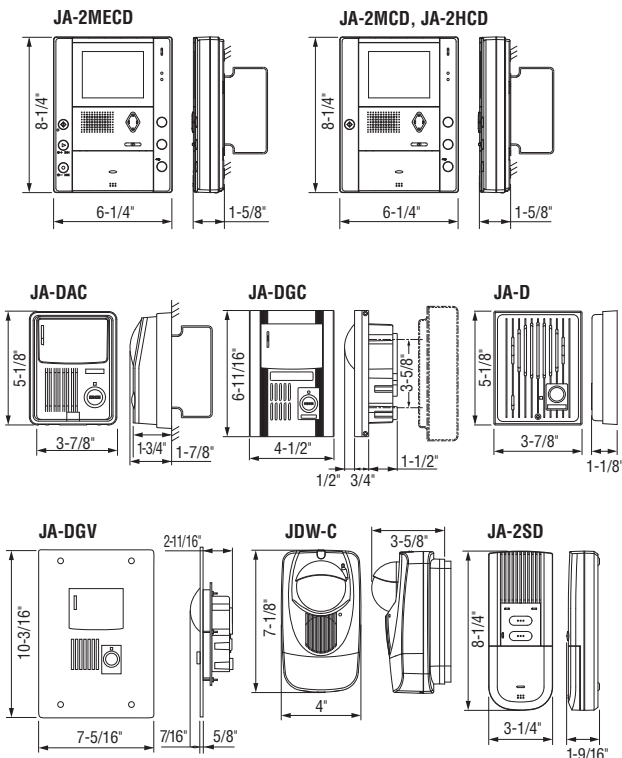

Specifications

Power Source	24V DC - Use PS-2420UL
Calling	Chime, image and audio approx. 30 sec.
Communication	AUTOMATIC (hands-free) - to activate, momentarily press TALK button MANUAL (press-to-talk/release-to-listen) - to activate, press TALK button for 2 sec. or until talk LED turns on
Video Monitor	4" direct-view TFT color LCD
Scanning Line	525 lines
Image View Area	Approx. 2' horizontal, 3'8"~7'9" vertical at 4'3" high and at 20" in front of camera
Night Viewing	Up to 1' from camera, with white LED projected, background beyond 1' cannot be seen
Door Release	Contact rating: 24V AC/DC 500mA Use RY-24L for larger contact rating, one per door
Wiring	Door to master: 2-cond., mid cap, solid, non-shielded Master to subs: 4-cond., mid cap, solid, non-shielded
Distance	Master to door: 165'(22AWG) 330'(18AWG) Master to farthest sub: 165'(22AWG) 330'(18AWG) Master to IER-2: 245'(22AWG) 490'(18AWG)
Wire Type	Master to door: Aiphone #871802 Between masters/subs: Aiphone #871804



DOOR 2 **INSIDE 3** **JF-2MED**
Hands-free Color Video

Door Stations - Max. 2 doors

DOOR 1 OPTIONS
Choose ONE of the following

JF-DA
Fixed Video Door Station, plastic cover, surface mount

JF-DV
Fixed Video Door Station, zinc die cast, surface mount

JF-DVF
Fixed Video Door Station, stainless steel, flush mount

JF-DVF-HID-I (Shown)
Fixed Video Door Station with embedded HID® iCLASS™ Smart Card Reader, stainless steel, flush mount

DOOR 2 OPTIONS
Choose ONE of the following

JF-DA
Fixed Video Door Station, plastic cover, surface mount

JF-DV
Fixed Video Door Station, zinc die cast, surface mount

JF-DVF
Fixed Video Door Station, stainless steel, flush mount

JF-DVF-HID-I (Shown)
Fixed Video Door Station with embedded HID® ProxPoint® Plus Proximity Card Reader, stainless steel, flush mount

JF-D
Audio Only Door Station, plastic cover, surface mount

JBW-M
CCTV Input Module

Inside Stations - Max. 3 rooms

INSIDE 1 OPTION
Choose ONE of the following

JF-2MED
Master Station with color monitor and Picture Memory

PS-1820UL
Power Supply, 18V DC, 2A

Features

- Quick and easy to install - Only 2 wires!
- No handset to pick up
- Compact, attractive design complements most interiors
- Open voice VOX or PTT communication
- High resolution color TFT monitor
- Expandable to three inside and two door stations
- Leave a voice memo to replay at inside stations
- Pre-record entrance messages
- Single or selective door release with RY-3DL
- Camera station can be monitored from inside
- All monitors turn on when camera station calls in
- Embedded HID® ProxPoint® Plus Proximity Card Reader
- Embedded HID® iCLASS™ Smart Card Reader

Camera View Area

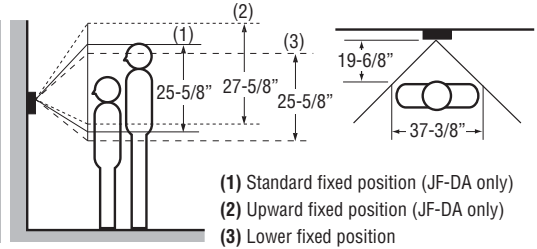

Wiring

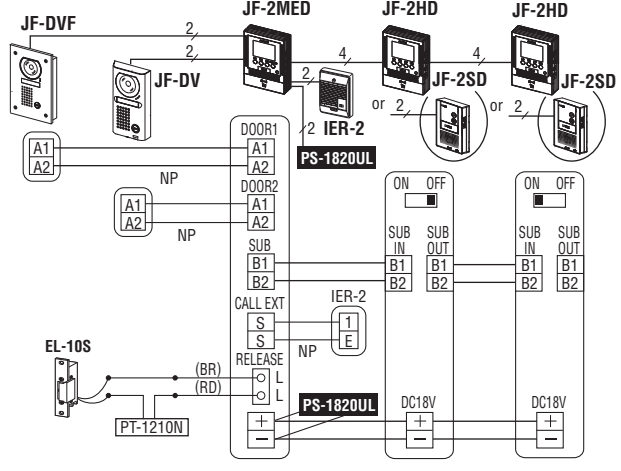

RY-3DL Connection

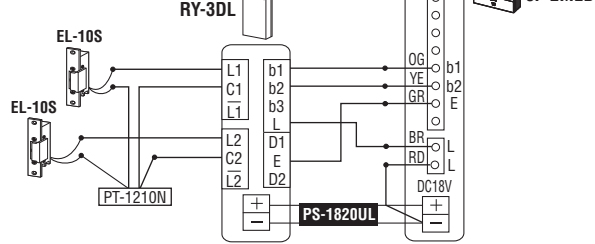

INSIDE
2
OPTIONS

Choose ONE of the following



JF-2HD
Sub Master Station with color monitor



JF-2SD
Audio Only Sub Master Station

INSIDE
3
OPTIONS

Choose ONE of the following



JF-2HD
Sub Master Station with color monitor



JF-2SD
Audio Only Sub Master Station

4 wires
Aiphone
#871804
(Max. 330'
between
master and
farthest sub)

Options & Accessories



AC-10S
Access Control Keypad, die cast to match JF-DV



KAW-D
30° Angle Box for JF-DA



MKW-P
1-Gang Mounting Plate for JF-DV



KMB-45
Mullion Mounting Bracket for JF-DA



SBX-LSE
Security Lock Box for JF-DV and JF-DVF (Lock not included)



SBX-DVF
Surface Mount Box for JF-DVF



SBX-DVF-P
Surface Mount Box for JF-DVF-HID and JF-DVF-HID-I



SBX-DV30
30° Surface Mount Box for JF-DV



MKW-DK/A
Motion Detector Adaptor for video door station



JBW-BA
Long Distance Door Station Adaptor



IER-2
Call Extension Speaker



EL-10S
Electric Door Strike, 12V AC, 180mA (Requires PT-1210N)



RY-3DL
Selective Door Release Adaptor



RY-24L
Form C High Current Door Release Relay (1 door)



TAR-3
External Signaling Relay (Requires SKK-620B)



MCW-S/A
Monitor Desk Stand

Boxed Sets



JFS-2AED: JF-2MED, JF-DA & power supply
JFS-2AEDV: JF-2MED, JF-DV & power supply
JFS-2AEDF: JF-2MED, JF-DVF & power supply

Unit Dimensions

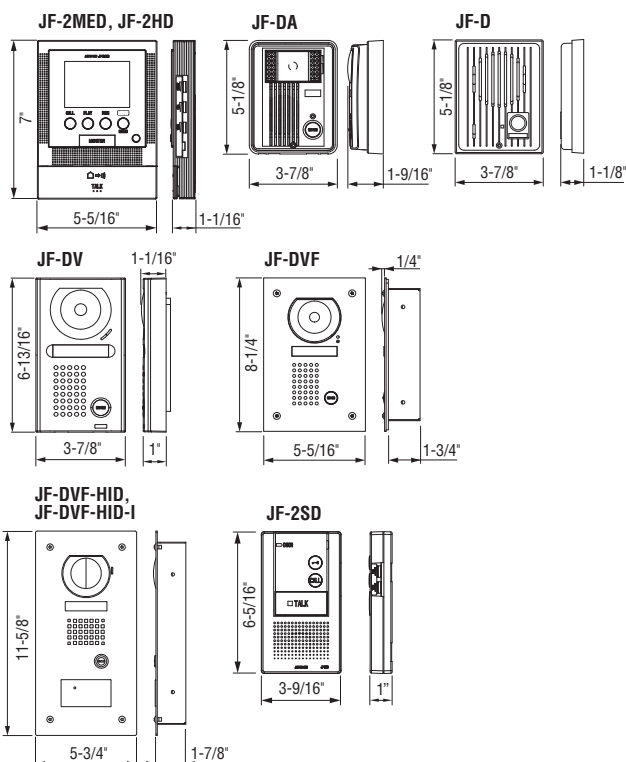

Specifications

Power Source	18V DC - Use PS-1820UL
Calling	Chime, image and audio approx. 45 sec.
Communication	AUTOMATIC (hands-free) - to activate, momentarily press TALK button MANUAL (press-to-talk/release-to-listen) - to activate, press TALK button for 2 sec. or until talk LED turns on
Video Monitor	3-1/2" direct-view TFT color LCD
Scanning Line	525 lines
Night Viewing	Up to 1' from camera, with white LED projected, background beyond 1' cannot be seen
Picture memory	Record max. 50 images (8 pictures/image, 1 shot for each sec.) Save max. 10 recorded pictures
Voice memo	Record max. 3 voice memos (max. approx. 15 sec. /memo)
Msg. for entrance	Record max. 2 messages (max. approx. 10 sec. /message)
Door Release	Contact rating: 24V AC/DC, 500mA Use RY-18L for larger contact rating
Wiring	Door to master: 2-cond., mid cap, solid, non-shielded Master to sub: 4-cond., mid cap, solid, non-shielded
Distance	Door to master: 165'(22AWG) 330'(18AWG) Master to farthest sub master: 165'(22AWG) 330'(18AWG) Master to IER-2: 245'(22AWG) 490'(18AWG)
Wire Type	Master to door: Aiphone #871802 Between masters/subs: Aiphone #871804

DOOR
1

INSIDE
2

JF-1MD

Hands-free Color Video



Door Station - Max. 1 door

DOOR
1
OPTIONS

Choose ONE of the following



JF-DA
Fixed Video Door Station, plastic cover, surface mount



JF-DV
Fixed Video Door Station, zinc die cast, surface mount



JF-DVF
Fixed Video Door Station, stainless steel, flush mount



JF-DVF-HID
Fixed Video Door Station with embedded HID® ProxPoint® Plus Proximity Card Reader, stainless steel, flush mount

JF-DVF-HID-I (Shown)
Fixed Video Door Station with embedded HID® iCLASS™ Smart Card Reader, stainless steel, flush mount

2 wires
Aiphone
#871802
(Max. 330')



EL-10S
Door Strike

Inside Stations - Max. 2 rooms

INSIDE
1
OPTION



JF-1MD
Master Station with color monitor

NOTE:
Room to room communication is not possible between the inside stations

6 wires
Aiphone
#871806
(Max. 330'
between door station and farthest sub)

2 wires
Aiphone
#871802
(Max. 33')



PS-1820UL
Power Supply,
18V DC, 2A

Features

- Quick and easy to install - Only 2 wires!
- No handset to pick up
- Compact, attractive design complements most interiors
- Open voice VOX or PTT communication
- High resolution color TFT monitor
- Includes single N/O door release contact
- Camera station can be monitored from inside
- All monitors turn on when camera station calls in
- Embedded HID® ProxPoint® Plus Proximity Card Reader
- Embedded HID® iCLASS™ Smart Card Reader

Wiring

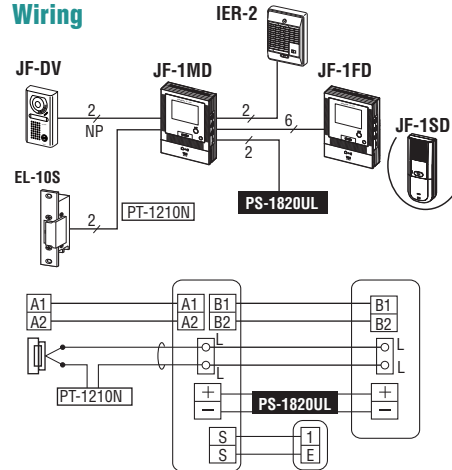

Camera View Area

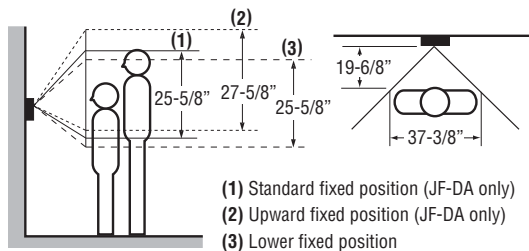

- (1) Standard fixed position (JF-DA only)
- (2) Upward fixed position (JF-DA only)
- (3) Lower fixed position

INSIDE 2 OPTIONS

Choose **ONE** of the following



JF-1FD
Sub Master Station with color monitor



JF-1SD
Audio Only Sub Master Station

Options & Accessories

 <p>AC-10S Access Control Keypad, die cast to match JF-DV</p>	 <p>KAW-D 30° Angle Box for JF-DA</p>	 <p>MKW-P 1-Gang Mounting Plate for JF-DV</p>	 <p>KMB-45 Mullion Mounting Bracket for JF-DA</p>	 <p>SBX-LSE Security Lock Box for JF-DV and JF-DVF (Lock not included)</p>
 <p>SBX-DVF Surface Mount Box for JF-DVF</p>	 <p>SBX-DVF-P Surface Mount Box for JF-DVF-HID and JF-DVF-HID-I</p>	 <p>SBX-DV30 30° Surface Mount Box for JF-DV</p>	 <p>MKW-DK/A Motion Detector Adaptor for video door station</p>	
 <p>JBW-BA Long Distance Door Station Adaptor</p>	 <p>EL-10S Electric Door Strike, 12V AC, 180mA (Requires PT-1210N)</p>	 <p>RY-24L Form C High Current Door Release Relay (1 door)</p>	 <p>IER-2 Call Extension Speaker</p>	 <p>MCW-S/A Monitor Desk Stand</p>

Boxed Sets



- JFS-1AD:** JF-1MD, JF-DA & power supply
- JFS-1ADV:** JF-1MD, JF-DV & power supply
- JFS-1ADF:** JF-1MD, JF-DVF & power supply

Unit Dimensions

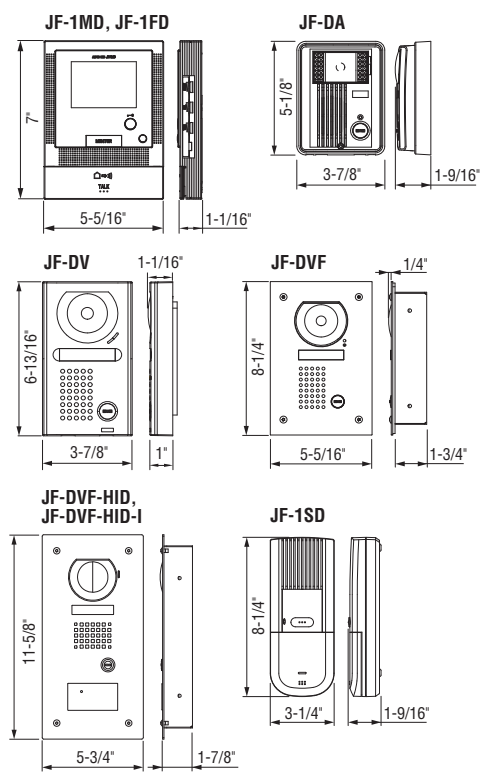

Specifications

Power Source	18V DC - Use PS-1820UL
Calling	Chime, image and audio approx. 45 sec.
Communication	AUTOMATIC (hands-free) - to activate, momentarily press TALK button MANUAL (press-to-talk/release-to-listen) - to activate, press TALK button for 2 sec. or until talk LED turns on
Video Monitor	3-1/2" direct-view TFT color LCD
Scanning Line	525 lines
Min. Illumination	5 Lux at 1' distance
Night Viewing	Up to 1' from camera, with white LED projected, background beyond 1' cannot be seen
Door Release	Contact rating: 24V AC/DC, 500mA Use RY-18L for larger contact rating
Wiring	Door to master: 2-cond., mid cap, solid, non-shielded Master to sub: 6-cond., mid cap, solid, non-shielded
Distance	Door to farthest master/sub master: 165'(22AWG) 330'(18AWG) Master to IER-2: 245'(22AWG) 490'(18AWG)
Wire Type	Master to door: Aiphone #871802 Between masters/subs: Aiphone #871806



Door Stations - Max. 1 door

DOOR 1
OPTIONS

Choose ONE of the following



KC-DAR
Color Tilt Video Door Station, plastic cover, surface mount



KCW-M
CCTV Input Module
(To be used with the JA-D door station to provide audio communication)

Inside Stations - Max. 3 rooms

INSIDE 1
OPTION

Choose ONE of the following



KC-1GRD
Master Station

INSIDE 2-3
OPTIONS

Choose ONE of the following



KC-1HRD
Sub Station



KC-1SD
Audio Only Sub Master Station

2 wires
Aiphone #871802 (Max. 330')

2 wires
EL-10S Door Strike

2 wires
Aiphone #871802 (Max. 330' between master and farthest sub)

2 wires
Aiphone #871802 (Max. 33')

PS-2420UL
Power Supply, 24V DC, 2A

2 wires
Aiphone #871802 (Max. 33')

PS-2420UL
Power Supply, 24V DC, 2A

Options & Accessories



KA-DGR Panel
Housing Panel for KC-DAR, stainless steel, surface mount



KA-FSH
Housing Panel, stainless steel, flush mount



KAW-D
30° Angle Box for KC-DAR



KMB-45
Mullion Mounting Bracket for KC-DAR



SBX-ACE
Surface Mount Box for intercom and access control device



EL-10S
Electric Door Strike, 12V AC, 180mA (Requires PT-1210N)



RY-24L
Form C High Current Door Release Relay (1 door)



KC-32EU
Picture Memory Unit



KCW-D/B
Output Converter to CCTV



MKW-DK/A
Motion Detector Adaptor for video door station(s)



IER-2
Call Extension Speaker



TAR-3
External Signaling Relay (Requires SKK-620B)



MCW-S/A
Monitor Desk Stand

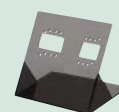

MCW-2S
Monitor/Picture Memory Unit Desk Stand

Features

- Clear and bright image with color TFT LCD monitor and color video door station
- TILT camera control
- Instant voice call-in with image
- White LED illuminator
- All Call type room calling
- Hands-free audio and video monitoring
- 330' total distance looped between monitors

Specifications

- Power Source** 24V DC - Use PS-2420UL
- Calling** Chime, image and audio approx. 30 sec., hear and see door instantly
- Communication** Pick up at any station to reply, 2-1/2 min. timed, recycle with MONITOR, monitor hands-free audio and image of door with MONITOR, press All Call to call the other with pre-tone and voice, lift either handset to reply
- Video Monitor** 4" direct-view TFT color LCD
- Scanning Line** 525 lines
- Image View Area** Approx. 2' horiz., 3'8"~7'9" vertical at 20" in front of camera at 4'3" high
- Night Viewing** Up to 1' from camera, with white LED projected, background beyond 1' cannot be seen
- Door Release** Contact rating: 12V AC, 400mA. Use RY-24L for larger contact rating
- Wiring** Door to master: 2-cond., mid cap, solid, non-shielded
Master to subs: 2 x 2-cond., mid cap, solid, non-shielded
- Distance** Master to door: 165'(22AWG) 330'(18AWG)
Master to farthest sub: 165'(22AWG) 330'(18AWG)
Master to IER-2: 165'(22AWG) 330'(18AWG)
- Wire Type** Aiphone #871802

Unit Dimensions

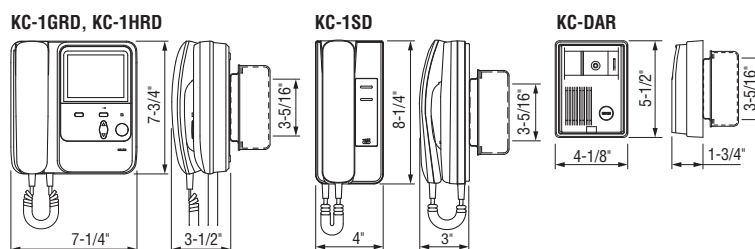

Wiring

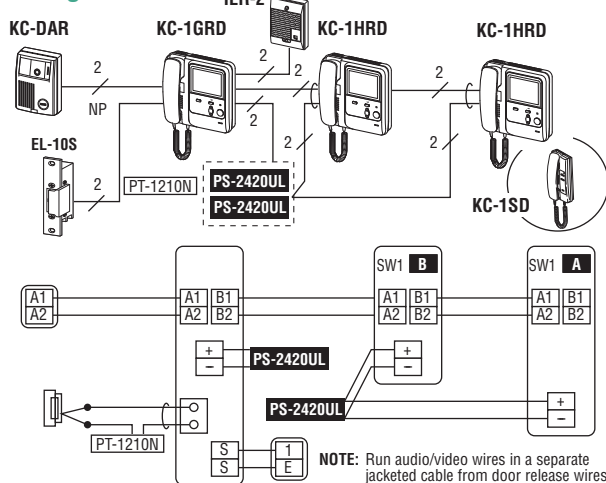



COMMERCIAL

- CONTROLLED ENTRANCES
- INTERIOR OFFICES
- ELEVATORS
- CONSTRUCTION ZONES
- STADIUMS & EVENT ARENAS
- LOADING DOCKS
- PARKING GARAGES



CORRECTIONAL

- CONTROLLED ENTRANCES
- MAN TRAPS / SALLY PORTS
- GATED PERIMETERS
- GUARD TOWERS
- CELL BLOCKS
- PRISON YARDS
- LOADING DOCKS



EDUCATIONAL

- CONTROLLED ENTRANCES
- ADMINISTRATIVE OFFICES
- COMMON AREAS
- CLASSROOMS
- PORTABLES
- DORMITORIES
- PARKING LOTS



HEALTHCARE

- CONTROLLED ENTRANCES
- ADMINISTRATIVE OFFICES
- EXAM ROOMS
- NURSE STATIONS
- PHARMACIES
- NURSERIES
- ASSISTED LIVING



GOVERNMENT

- LOCAL & FEDERAL GVRNMTS
- COURTHOUSES & CITY HALLS
- EMBASSIES & CONSULATES
- POLICE & FIRE STATIONS
- BORDER CONTROL
- TRANSPORTATION
- PUBLIC UTILITIES

FEATURE MATRIX



	AX Series	KB Series	JA Series	JF-2MED	JF-1MD	KC Series	
INSTALLATION	Max. Door Station Qty.	120	3	2	2	1	1
	Max. Master Station Qty.	8	5	3	3	2	3
	Wiring <small>ABOVE: Door to Inside Station BELOW: Between Inside Station(s)</small>	CAT-5e CAT-5e	2 wires 4 wires	2 wires 4 wires	2 wires 4 wires	2 wires 4 wires	2 wires 4 wires
	Wiring Style	Homerun	Daisy Chain	Daisy Chain	Daisy Chain	Daisy Chain	Daisy Chain
INSIDE / MASTER STATION	Communication	Hands-free Press-to-Talk	Handset	Hands-free Press-to-Talk	Hands-free Press-to-Talk	Hands-free Press-to-Talk	Handset
	Selective Call	✓	✓				
	All Call	✓	✓	✓	✓		✓
	Internal Communication	✓	✓	✓	✓		✓
	Call Transfer to Inside Station	✓	✓	✓	✓		✓
	Call Transfer to Telephone	✓					
	Internal Voice Memo				✓		
	Outgoing Msg. for Entrance				✓		
	Monitoring	✓	✓	✓	✓	✓	✓
	Scan Monitoring	✓					
	Internal picture memory			✓	✓		
	Electric Door Strike/Release	✓	✓	✓	✓	✓	✓
	Video Signal output (NTSC)	✓	✓	✓	✓	Requires KCW-D/B	Requires KCW-D/B
DOOR STATION	Vandal resistant	✓	✓	✓	✓	✓	✓
	Wide Angle Camera	✓	with Tilt	with PanTilt	✓	✓	with Tilt
	Automatic LED for Night Viewing	✓	✓	✓	✓	✓	✓
	Embedded Card Reader	✓			✓	✓	
OPTIONAL	Max. Call Extension Qty.	IER-2	IER-2	IER-2	IER-2	IER-2	IER-2
	External Contact Switch				✓	✓	
	External Picture Memory		KC-32EU				KC-32EU
INTEGRATION	Access Control	✓	✓	✓	✓	✓	✓
	CCTV Input	✓	✓	✓	✓		
	Fiber Optic / IP Adaptor	✓					

Distributed by:

91204
Color Video Brochure 6/08
Printed in the USA

GSA Schedule
GS-35F-0065L

ISO-14001
Certified
 Aiphone Co. Ltd.

ISO 9001:2000
Certified
 Aiphone Corp.

Deming
Prize
 Aiphone Co. Ltd.

AIPHONE®

Aiphone Corporation
1700 130th Ave. NE
Bellevue, WA 98005
Phone: (800) 692-0200
Fax: (425) 455-0071
www.aiphone.com/colorvideob.htm